

Global Positioning Radiometric Scanner System

Deactivation and Decommissioning Focus Area



Prepared for
U.S. Department of Energy
Office of Environmental Management
Office of Science and Technology
March 2001



Global Positioning Radiometric Scanner System

OST/TMS ID 2954

Deactivation and Decommissioning Focus Area

Demonstrated at
Idaho National Engineering and Environmental Laboratory
Large-Scale Demonstration and Deployment Project
Idaho Falls, Idaho

INNOVATIVE TECHNOLOGY

Summary Report

Purpose of this document

Innovative Technology Summary Reports are designed to provide potential users with the information they need to quickly determine whether a technology would apply to a particular environmental management problem. They are also designed for readers who may recommend that a technology be considered by prospective users.

Each report describes a technology, system, or process that has been developed and tested with funding from DOE's Office of Science and Technology (OST). A report presents the full range of problems that a technology, system, or process will address and its advantages to the DOE cleanup in terms of system performance, cost, and cleanup effectiveness. Most reports include comparisons to baseline technologies as well as other competing technologies. Information about commercial availability and technology readiness for implementation is also included. Innovative Technology Summary Reports are intended to provide summary information. References for more detailed information are provided in an appendix.

Efforts have been made to provide key data describing the performance, cost, and regulatory acceptance of the technology. If this information was not available at the time of publication, the omission is noted.

All published Innovative Technology Summary Reports are available on the OST Web site at <http://ost.em.doe.gov> under "Publications."

TABLE OF CONTENTS

1. SUMMARY	page 1
2. TECHNOLOGY DESCRIPTION	page 6
3. PERFORMANCE	page 10
4. TECHNOLOGY APPLICABILITY AND ALTERNATIVES	page 14
5. COST	page 15
6. REGULATORY AND POLICY ISSUES	page 20
7. LESSONS LEARNED	page 21

APPENDICES

A. REFERENCES	page A-1
B. COST COMPARISON DETAILS	page B-1
C. ADDITIONAL GPRS RESULTS	page C-1
D. ACRONYMS AND ABBREVIATIONS	page D-1

SECTION 1 SUMMARY

Technology Summary

The United States DOE continually seeks safer and more cost-effective technologies for use in decontamination and decommissioning (D&D) of nuclear facilities. To this end, the Deactivation and Decommissioning Focus Area (DDFA) of the DOE OST sponsors the Large Scale Demonstration and Deployment Projects (LSDDP). At these LSDDPs, developers and vendors of improved or innovative technologies showcase products that are potentially beneficial to the DOE projects and to others in the D&D community. Benefits sought include decreased health and safety risks to personnel and the environment, increased productivity, and decreased costs of operation.

The Idaho National Engineering and Environmental Laboratory (INEEL) LSDDP generated a list of statements defining specific needs or problems where improved technology could be incorporated into ongoing D&D tasks. One of the stated needs was for developing technologies that would reduce costs and shorten D&D schedules by providing radiological characterizations to meet the free-release criteria.

The Global Positioning Radiometric Scanner (GPRS system shown in Figure 1) utilizes a detection system; a portable computer, a differential global positioning system (d-gps), and a four wheel drive vehicle. Once the survey data has been collected, a software program called GeoSoft™ generates a graphical representation of the radiological contamination extent. Baseline technology involves gridding the area and hand surveying each grid.



Figure 1. The Global Positioning Radiometric Scanner System used at the INEEL.

This demonstration investigated the associated costs and the required time to evaluate the radiological characterization data from the GPRS with respect to the baseline technology. The GPRS system performs in-situ, real-time analyses to identify the extent of radiological contamination. Benefits expected from using the new innovative technology (GPRS) include:

- Reduced labor hours associated with performing the survey
- Increased number of survey data points
- Reduced exposure to radiation
- Shortened D&D schedules
- Reduced operating costs
- Real time, in-situ radiological measurements
 - Visual representation of the extent of radiological contamination
 - More accurate and reproducible survey results.

Technology Summary

Baseline Technology

Historically at the INEEL, large area surveys have been conducted using hand-held monitors (see Figure 2). For meeting the free release criteria, the Radiological Control Technician (RCT) uses a portable sodium-iodide (NaI) detector to gather radiological information about this area. If the RCT detected any elevated readings during the survey, a Bicorn μ R meter was used to determine the exact radiological activity and compared to the release limits. During this survey, the RCT records all information into a field logbook and documents any elevated areas. This information is later transcribed onto a map and reported to the D&D Facility Manager.



Figure 2. Baseline Technology uses to characterize a survey grid.

Innovative Technology

At the INEEL, the GPRS system is operated by the Environmental Surveillance Program (ESP) for conducting routine large area surface radiation surveys. These surveys are part of a routine surveillance program and are conducted outside the facility fence lines and within known contaminated soil areas to ensure no migration of the contaminants has occurred.

The GPRS system (as shown in Figure 3) utilizes a detection system, differential global positioning system (d-gps), a portable computer, and a four-wheel drive vehicle. The detection system consists of two 4 in. x 26 in. x 1.5 in. plastic scintillators housed in an 8 in. x 8 in. x 72 in. white enamel steel box. Each scintillator uses an independent amplifier channel on a single channel analyzer board and shares a common high voltage power source; however, the same lower limit of detection and upper limit of detection controls control both of the single channel analyzer channels. In addition, each detector is shielded with a 1/8 in. of lead on the top, sides, and ends to allow the system to collect measurements directly below the unit.



Figure 3. The GPRS surveying an area.

Demonstration Summary

The GPRS was demonstrated in September 1999 at one of the INEEL facilities as part of the INEEL LSDDP. This demonstration occurred at the INEEL Initial Engine Test (IET) facility on the IET stack trench, an area approximately 80 ft by 100 ft. The IET stack was dropped into a trench as part of the D&D efforts. The trench was then covered with soil to provide a radiological barrier. This terrain was mostly flat and covered with crested wheatgrass, making for an ideal survey area. No obstacles, with the exception of the trench monument, were noted inside the demonstration area. This demonstration started in the morning and was completed before noon. The GPRS identified the extent of contamination, as well as one small area of subsidence with radiation readings above background at the Initial Engine Test (IET) facility (shown in Figure 4). Background radiation reading for IET was defined as 13 $\mu\text{R/hr}$ and was determined by the Radiological Control Technician (RCT).

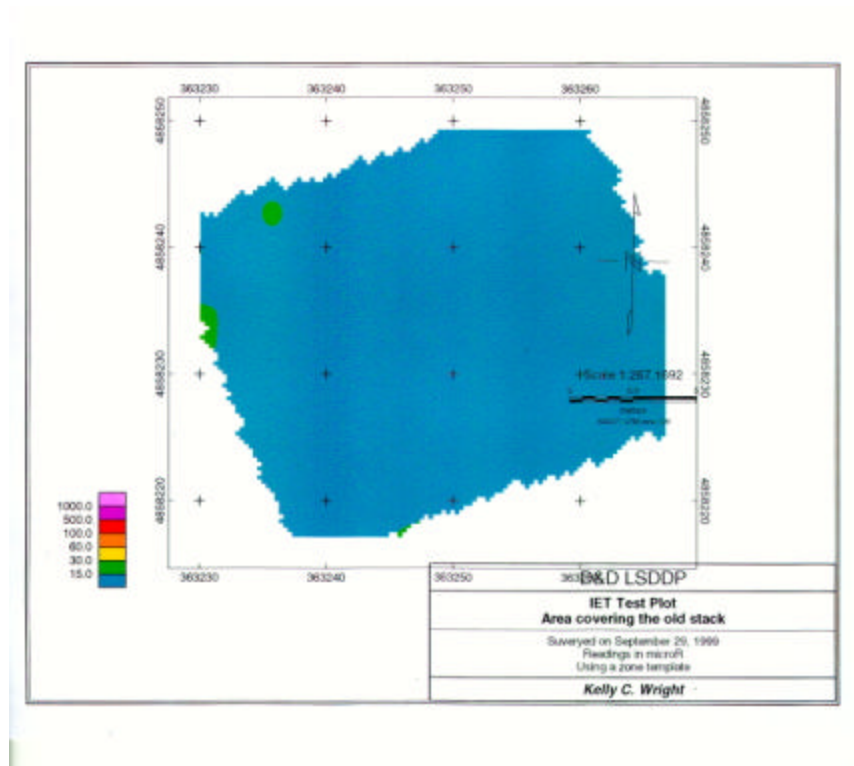

Figure 4. Graphical display of the GPRS survey result from IET stack trench.

Key Points

The key points of this demonstration are summarized below. Detailed descriptions and explanations of these results are found in Section 3 of this report:

- 76% reduction in survey labor hours
- Increased number of survey data points
 1. 591 data points by the GPRS
 2. Range of 12 to 20 $\mu\text{R/hr}$ with baseline
 3. A direct comparison of the number of data points can not be made between these two technologies. The GPRS records information every two seconds while hand surveys will only indicates a range of the activity observed during the survey.
- More accurate and reproducible survey results
 1. GPS accuracy – less than 20 centimeters (cm)
 2. Baseline accuracy – varies upon the survey pattern (maximum value would be 91 cm)
- Real time, in-situ radiological measurements
- Visual representation of the extent of radiological contamination.

Contacts

Technical

Technical Information on the Global Positioning Radiometric Scanner System

Charlie Schnurr, TSA Systems, Longmont, CO (303) 651-6147 charlie@tsasystems.com

Technology Demonstration

Harold Thorne, D&D Project Manager, Idaho National Engineering and Environmental Laboratory, (208) 526-8078, ht@inel.gov

Kelly C. Wright, Test Engineer, Idaho National Engineering and Environmental Laboratory, (208) 526-2299, wck@inel.gov

Management

Steve Bossart, Project Manager, U.S. Department of Energy, National Energy and Technology Laboratory, (304) 285-4643, steven.bossart@netl.doe.gov

Chelsea Hubbard, U.S. Department of Energy, Idaho Operations Office, (208) 526-0645, Hubbardcd@inel.gov

Dick Meservey, INEEL Large Scale Demonstration and Deployment Project, Project Manager, Idaho National Engineering and Environmental Laboratory, (208) 526-1834, rhm@inel.gov

Cost Analysis

Wendell Greenwald, U.S. Army Corps of Engineers, (509) 527-7587, wendell.l.greenwald@usace.army.mil

Tim Jamison, Project Time & Cost Inc. Falls Church, VA, (703) 241-7900, tjamison@ptcinc.com

Web Site

The INEEL LSDDP Internet web site address is <http://id.inel.gov/lstdp>

Licensing

No license was required. The GPRS system was purchased from TSA Systems.

Permitting

No permitting activities were required.

Other

All published Innovative Technology Summary Reports are available on the OST Web site at <http://ost.em.doe.gov> under "Publications." The Technology Management System, also available through the OST Web site, provides information about OST programs, technologies, and problems. The OST reference number for the Global Positioning Radiometric Scanner System is #2954.

SECTION 2 TECHNOLOGY DESCRIPTION

Overall Process Definition

Demonstration Goals and Objectives

The overall purpose of this demonstration was to assess the benefits that may be derived from using the GPRS system for meeting free-release criteria. The GPRS was compared with the baseline technology, which is dividing the area into smaller grids and hand surveying each one. The primary goal of the demonstration was to collect valid characterization data to make a legitimate comparison between the GPRS system and the baseline technology in the following areas:

- Cost
- Productivity rates
- Ease of use
- Limitations and benefits.

Description of the Technology

The GPRS system is a technology used at the INEEL in contaminated soil areas to conduct routine large area gamma radiation surveys (shown in Figure 3). The GPRS (shown in Figure 5) utilizes a detection system; a portable computer, d-gps, and a four wheel drive vehicle. The detection system consists of two 4 in. x 26 in. x 1.5 in. plastic scintillators housed in an 8 in. x 8 in. x 72 in. white enamel steel box. Each scintillator uses an independent amplifier channel on a single channel analyzer board and shares a common high voltage power source; however, the same lower limit of detection and upper limit of detection controls control both of the single channel analyzer channels. In addition, each detector is shielded with an approximately 1/8-in. lead on the top and sides to allow the system to collect measurements directly below the unit.

The GPRS system operated at a speed of approximately 5 miles per hour (mph) to collect the most accurate gamma radiometric data. The detectors are mounted on the front of the four-wheel drive vehicle at a height of 3 ft. The detector system weighs approximately 250 pounds.

During operation, the detector interfaces with the computer and displays the following information: radiometric data (in counts per second for each of the individual detectors), geographical data (both latitude and longitude coordinates), altitude, time, and date. The system records the gamma radiometric data along with the associated geographical coordinates in memory on the onboard computer. This information is updated approximately every two seconds with the new data.

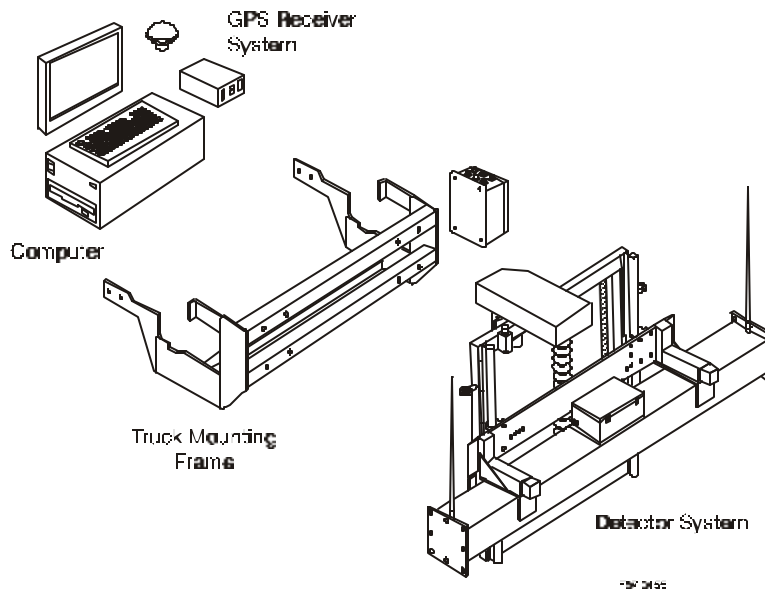

Figure 5. The framework of the GPRS system used at the INEEL.

Specific advantages of the GPRS included the following:

- Versatility of the four wheel drive
- Reducing the time in contaminated soil areas (reduces exposures)
- Using differential-gps data rather than post-processing the geographic coordinates
- Reporting software designed to handle vast amounts of environmental data.

System Operation

Table 1 summarizes the operational parameters and conditions of the GPRS demonstration.

Table 1: Operational parameters and conditions of the GPRS demonstration.

Working Conditions	
Work area location	<ul style="list-style-type: none"> Initial Engine Test facility (IET)
Work area access	Access controlled by D&D project through use of fencing and posting
Work area description	<ul style="list-style-type: none"> In order to gain access to IET, the D&D Facility Manager was notified and the arrangements to use his key to unlock the gate. No D&D activities were scheduled. Upon arrival, the access gate was open and we notified the Facility Manager about it, after we had gone down to the area and found nobody around. IET is fenced and posted as a controlled area and has a sign stating, "Safety Shoes Required for Entry" due to the D&D activities in the area. The survey area is located inside the IET facility fence line and IET is considered to be part of Test Area North complex. The trench (survey area) was marked with a monument identifying where the stack was buried underneath the ground. The ground surface was smooth and free of any stored items. The vegetation was mostly crested wheatgrass. Photographic services recorded this demonstration.
Work area hazards	<ul style="list-style-type: none"> Tripping Heavy equipment operations Temperature extremes Driving
Equipment configuration	The HUMMER was driven up to IET. The GPRS instrumentation is mounted to front of this vehicle. The vehicle, driven to the work site by the field operator, transported the test engineer and the Radiation Control technician. The HUMMER (GPRS) is generally located at CFA-615 and controlled by the Environmental Surveillance Program. Personnel must be as a trained source handler to perform the daily response check on the equipment.
Labor, Support Personnel, Specialized Skills, Training	
Work Crew	Minimum work crew: <ul style="list-style-type: none"> 1 Field Operator 1 RCT
Additional support personnel	<ul style="list-style-type: none"> 1 Data collector 1 Test Engineer 1 Health and Safety Observer (periodic)
Specialized skills/training	<ul style="list-style-type: none"> TSA Systems had provided training on the operation of the GPRS to the field operators (i.e., Environmental Surveillance Program personnel). OSHA Source handler training is required to check out the radiological source used to response check the equipment
Waste Management	
Primary waste generated	No primary wastes were generated.
Secondary waste generated	No secondary wastes were generated.
Waste containment and disposal	No wastes were generated so no containment was necessary.
Equipment Specifications and Operational Parameters	
Technology design purpose	To identify surface gamma radionuclide contamination in large area surveys.
Specifications	<ul style="list-style-type: none"> Four wheel drive vehicle (HUMMER license #E71420) Mounting Bracket (2) Thompson Rods used as guides for raising and lowering the detector system

	<ul style="list-style-type: none"> • (1) motor used for raising and lowering • (2) 4 in. x 26 in. x 1.5 in. plastic scintillators with 1/8 in. lead shielding on the top, sides and ends • (1) High voltage power supply • (2) Single channel analyzers • (1) Multi-channel Analyzer • (1) 8 in. x 8 in. x 72 in. white enamel steel box • 486 MHz personal computer used to collect and store the survey information • Trimble AgGPS Model 132 receiver and antenna • Differential-GPS signal (provided by OmniStar©) • 250-lbs for the detector system • Geosoft™ software used for mapping 3-D models of environmental constituents.
Portability	The GPRS system is attached to the front of a four-wheel drive vehicle (A HUMMER as shown in Figure 1). The detector box can be removed from the mounting bracket assembly (see Figure 4). As well, the d-GPS antenna can be removed during the adverse winter weather conditions to prevent the antenna from collecting moisture inside the sphere containing the electronic components.
Materials Used	
Work area preparation	Four orange colored flags were placed in the ground at each of the corners. A tape measure was used to measure the distance between them. The grid size was determined to be 80 ft x 100 ft. Additional radiological instrumentation was brought along as were personnel protective equipment (PPE) for working in a radiological environment.
Personal protective equipment (PPE)	Safety shoes were the only required PPE. Since this survey was completed several years prior, additional instrumentation and PPE were brought along in case any radiologically elevated areas were identified.
Utilities/Energy Requirements	
Power, fuel, etc.	No specific utilities/energy requirements for this demonstration. However, diesel was used in the HUMMER to get the personnel and instrumentation to the work site. The baseline technology instrumentation utilized batteries for operation while the GPRS used the HUMMER's electrical power for operation.

SECTION 3 PERFORMANCE

Demonstration Plan

Problem Addressed

As with other DOE facilities, the INEEL is in the process of decontaminating facilities, buildings, and areas that have been or have had the potential for radiological contamination. A characterization tool enhancing the data generated by the surveys needed to be developed. As part of the data process, it should provide more accurate and reproducible survey information to eliminate transcription errors in locating contamination. In addition, visually displaying the extent of gamma contamination is highly desirable. This would allow the D&D Facility Manager the ability to show regulators how their clean-up criteria were designed.

The purpose of this demonstration is to compare the performance of the innovative technology (GPRS) to the baseline technology (hand surveying). This demonstration will be conducted at the INEEL IET. The survey area has been identified as the trench from the old IET stack and has been designed to be 80 ft by 100 ft in size. In addition to the comparability of these two technologies, the D&D Facility Manager will also use this information to document the decision for this area to be considered clean and meets the criteria established for free release.

Demonstration Site Description

The INEEL site occupies 569,135 acres (approximately 890 square miles) in Southeast Idaho. The site consists of several primary facility areas situated on an expanse of otherwise undeveloped, high-desert ecosystem. Structures at the INEEL are clustered within the primary facility areas, typically less than a few square miles in size and separated from each other by miles of undeveloped terrain.

The test area for this demonstration was the IET area, located at the north end of the INEEL's Test Area North. This area includes buildings and structures that were constructed in the early 1950s for the Aircraft Nuclear Propulsion Program. After that program ended in 1961, the area was used for the Space Nuclear Auxiliary Power Transient Program through 1967 and then for the Hallam Decontamination and Decommissioning Project for two years in the 1970s. Currently, the facility is being demolished. IET is relatively small in size and the D&D Program feels that part of their responsibility is to cover everything inside the facility fence line based on the experiments conducted there, as well as the vast amount of structural components dispersed across this facility.

Major Objectives of the Demonstration

The major objectives of this demonstration were to evaluate the GPRS against the baseline hand surveying in the following areas:

- Cost effectiveness (based on the size of area covered by the GPRS and the detailed survey reports)
- Safety
- Ease of Use
- Limitations.

Major Elements of the Demonstration

The intent of this demonstration was to gather information helpful in deciding which technology (i.e., GPRS or baseline hand surveying) would improve or enhance the D&D activities. This demonstration only included one demonstration area; however, additional survey information has been included from previous surveys conducted at the INEEL. The major elements for this demonstration were as follows:

- Surveying Time
- Documentation
- Number of Workers Required
- Safety
- Cost
- Feedback
- Advantages/Disadvantages.

Results

Both technologies were demonstrated during September 1999 on the area identified at IET. This demonstration utilized a baseline hand surveying technique compared to the GPRS. Every attempt was made to ensure that the surveys were conducted on the same grid under normal work operations. All personnel involved with this demonstration were requested to conduct their survey under normal operations with no special emphasis on the survey.

Before the demonstration started, the boundaries of the grid were identified and marked by ESP personnel (as shown in Figure 6). The demonstration started with the RCT conducting the baseline hand surveying technique. The RCT traversed the grid back and forth making 28 passes with a portable NaI detector to complete. It took the RCT a total of 65 minutes.



Figure 6. Marking the Grid at IET.

Next, the GPRS surveyed this same area. One of the features of this new technology is the ability to track onscreen where the survey has been (shown in Figure 7). The first step of the GPRS survey was to establish a boundary on-screen so the operator would be able to adequately cover the entire area without missing any locations inside the grid.

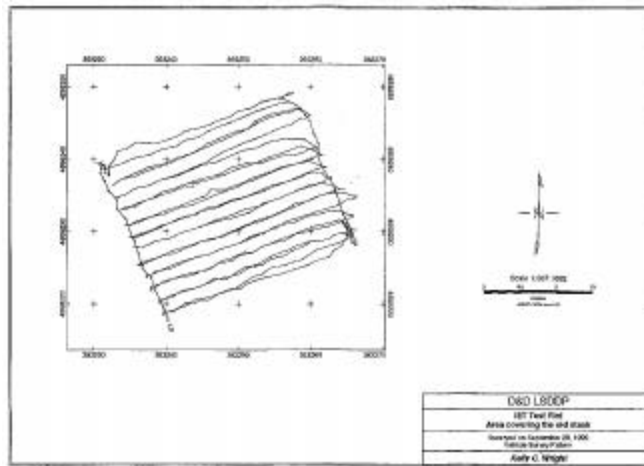

Figure 7. On-screen Tracking Capabilities of the GPRS.

During this demonstration, video footage was collected from both the baseline hand surveying and the GPRS. The performance of the two technologies is compared in Table 2. Additional large area surface radiation surveys results have been included in Appendix C to provide the potential end users will the applicability of this technology.

Table 2: Performance comparison between the GPRS and the baseline hand surveying technology.

Performance Factor	Baseline Hand Surveying Technology	GPRS Technology
Personnel/Equipment/ Time Required to Survey	Personnel: <ul style="list-style-type: none"> • 1 RCT Equipment: <ul style="list-style-type: none"> • 1 Bicron μR Meter • 1 Portable NaI Detector • 1 Field logbook Time: <ul style="list-style-type: none"> • 65 minutes 	Personnel: <ul style="list-style-type: none"> • 1 Sample Technician (Operator) Equipment: <ul style="list-style-type: none"> • 1 GPRS • 1 Zip disk • 1 Field Logbook Time: <ul style="list-style-type: none"> • 15 minutes
Time Required to Flag Grid	Personnel: <ul style="list-style-type: none"> • 2 Sample Technicians Equipment: <ul style="list-style-type: none"> • 4 Colored Flags • 1 Tape Measure Time: <ul style="list-style-type: none"> • 15 minutes 	Personnel: <ul style="list-style-type: none"> • 0 Equipment: <ul style="list-style-type: none"> • GPRS Time: <ul style="list-style-type: none"> • None, all information is recorded electronically during the survey
Time Required to Generate Report	Personnel: <ul style="list-style-type: none"> • 1 RCT Equipment: <ul style="list-style-type: none"> • 1 Personnel Computer • 1 Field Logbook Time: <ul style="list-style-type: none"> • 30 minutes 	Personnel: <ul style="list-style-type: none"> • 1 Engineer Equipment: <ul style="list-style-type: none"> • 1 Personnel Computer • 1 Zip disk with data • 1 Field Logbook • 1 Geosoft™ Software Time: <ul style="list-style-type: none"> • 10 minutes
Total Time per	<ul style="list-style-type: none"> • 110 minutes 	<ul style="list-style-type: none"> • 25 minutes

Technology		
PPE Requirements	<ul style="list-style-type: none"> • Safety shoes • Clothing Adequate for surveying 	<ul style="list-style-type: none"> • No specific PPE
Superior Capabilities	<ul style="list-style-type: none"> • By walking the entire area, the RCT could cover larger adverse terrains but not safely 	<ul style="list-style-type: none"> • GPRS was considered much easier to operate • This innovative technology has a larger “widow of view” • It is much faster and more efficient in collecting data • It can provide more real-time data • The final report includes a visual display of the extent of contamination found from the survey results

SECTION 4

TECHNOLOGY APPLICABILITY AND ALTERNATIVES

Competing Technologies

Baseline Technology

The baseline technology for this demonstration is dividing the area into individual grids and hand surveying using a portable NaI detector and verifying with a Bicron μ R meter if any elevated radiation readings were identified. There are various manufacturers that produce variations of the baseline technology.

Other Competing Technologies

A broad range of survey technologies is available, such as plastic scintillation or NaI detectors. However, the GPRS technology combines the geographic coordinates with the radiological information and provides an update approximately every two seconds. Once the data has been recorded on-board the computer, the file can be downloaded and interpreted through Geosoft™ software to visually display the extent of contamination.

Technology Applicability

The innovative technology is fully developed and commercially available. Its superior performance over the baseline technology makes it a prime candidate for deployment throughout the commercial sites. Many of the similar systems are being used across the DOE complex; however, the GPRS system does provide some added features to enhance the documentation process. The INEEL has deployed this technology on a variety of projects where surface contamination is of concern.

Patents/Commercialization/Sponsor

The GPRS system is commercially available from:

TSA Systems Inc.
1830 Boston Ave.
Longmont, CO 80501
Phone: (303) 651-6147 or (303) 651-6149
Fax: (303) 651-6823

Charlie Schnurr, Vice President
Charlie@tsasystems.com
Allan Frymire, President
Al@tsasystems.com

SECTION 5 COST

Introduction

This section compares the radiological survey cost for the innovative and the baseline technologies. The cost to use the innovative technology is approximately 76% of the baseline technology cost. The type of surveys typically used to monitor existing burial grounds is used as the basis of the cost comparison (periodic radiological surveys of the burial ground surface to detect any contaminant migration).

Methodology

This analysis is based on Government ownership of the equipment and use of on-site labor to perform the work. The costs for the innovative and baseline technologies are derived from observed duration or observed production rates for each of the work activities that comprise the work. The observed activities include response checks of the survey instruments, pre-job safety meetings, travel, marking the grid (for the baseline only), surveying the surface of the burial ground, and data reporting. The demonstration utilized two field samplers and a radiation control technician to perform much of the work. But, work crews used in the estimate are based on typical work situations at INEEL. A crew consisting of one radiation Control Technician is assumed for the baseline technology and a crew of one field sampler is assumed for the innovative technology. The labor rates for the crew are based on standard rates for the INEEL site. The survey equipment rates are based on the amortized purchase price. This cost analysis omits some non-productive costs. The demonstration began at 7:30 am and was completed by 11:50 am (required 4-hours and 20-minutes). But, the activities and duration included in this cost analysis account for only 2-hours and 40-minutes. Some of the activities omitted from this cost analysis related only to the demonstration (such as waiting on the photographer). Miscellaneous delays were also omitted if they did not relate directly to the work activity (such as the delay between the completion of the response check and the start of the pre-job briefing). Additional details of the basis of the cost analysis are described in Appendix B.

Cost Analysis

Costs to Purchase the Technology

The innovative technology is available from the vendor with optional components. The purchase price and installation for the global positioning system and the radiological survey instruments can vary from \$35,000 for a bare bones model to \$60,000 for systems similar to the one used in the demonstration. The costs of the equipment used in this demonstration are shown in Table 3.

Table 3. Improved technology acquisition costs

Acquisition Option	Item Description	Cost
Purchase	HUMMER	63,604
Purchase & Installation	GPS and Detector System	57,800

In addition to the purchase costs, there are costs for annual calibration/maintenance (INEEL anticipates approximately \$1,500 per year) and a cost for a differential correction signal subscription (approximately \$900 per year).

Unit Costs

Figures 8 and 9 shows the unit costs (\$/sf of surface surveyed) for the innovative and baseline technologies. The unit costs are based on the costs summarized in Appendix B, Table B-1 and B-2. The figures also show a relative percentage for each of the work activities observed during the demonstration. This percentage represents the activity's cost relative to the total unit cost of the job. Additionally, the site-specific conditions

that can significantly affect the cost of the activity are identified on the figure under the title Site Specific Conditions and this provides information about the conditions encountered for this demonstration. The percentage information and the condition information provide some indication of the potential variation in unit cost that may occur at other sites. The activities that are 1% to 5% of the total cost have little affect on the total cost, even if these activities have the potential for large variation. For example, if the survey area were uneven and slowed down the survey rate of the GPRS by 20%, there would be more time required. But this additional time would have little impact to the total cost and the unit cost. But, a moderate variation in cost of those activities that are 15% or more of the total unit cost will have a significant impact on the total. For example, if the baseline surveys were performed using 50% coverage rather than the 100% coverage used in the demonstration, then the unit cost for that situation would be significantly less than the unit cost computed for this demonstration. The size of the job affects the unit costs for both the innovative and the baseline. If the job size is 16,000 sf (rather than the 8,000 sf demonstration size) then the unit costs are approximately 60% of the unit costs shown below.

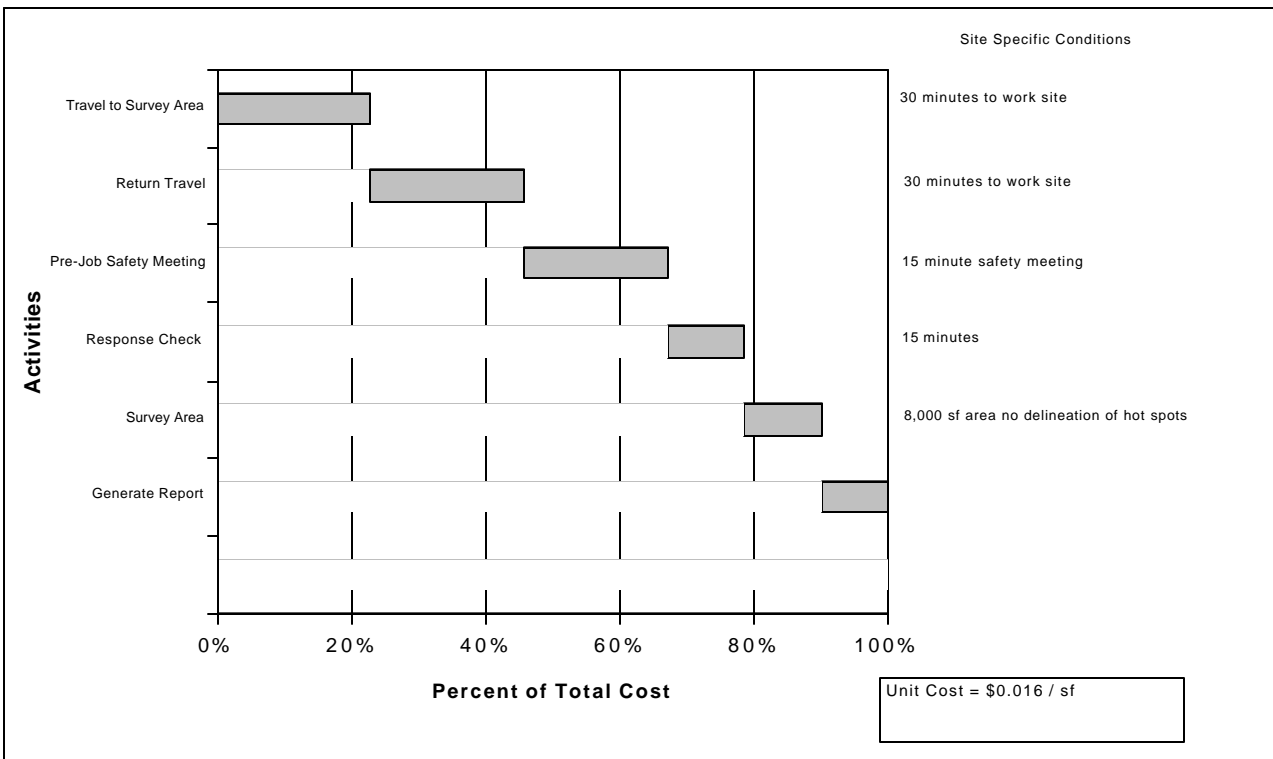

Figure 8. Breakdown of innovative technology unit cost.

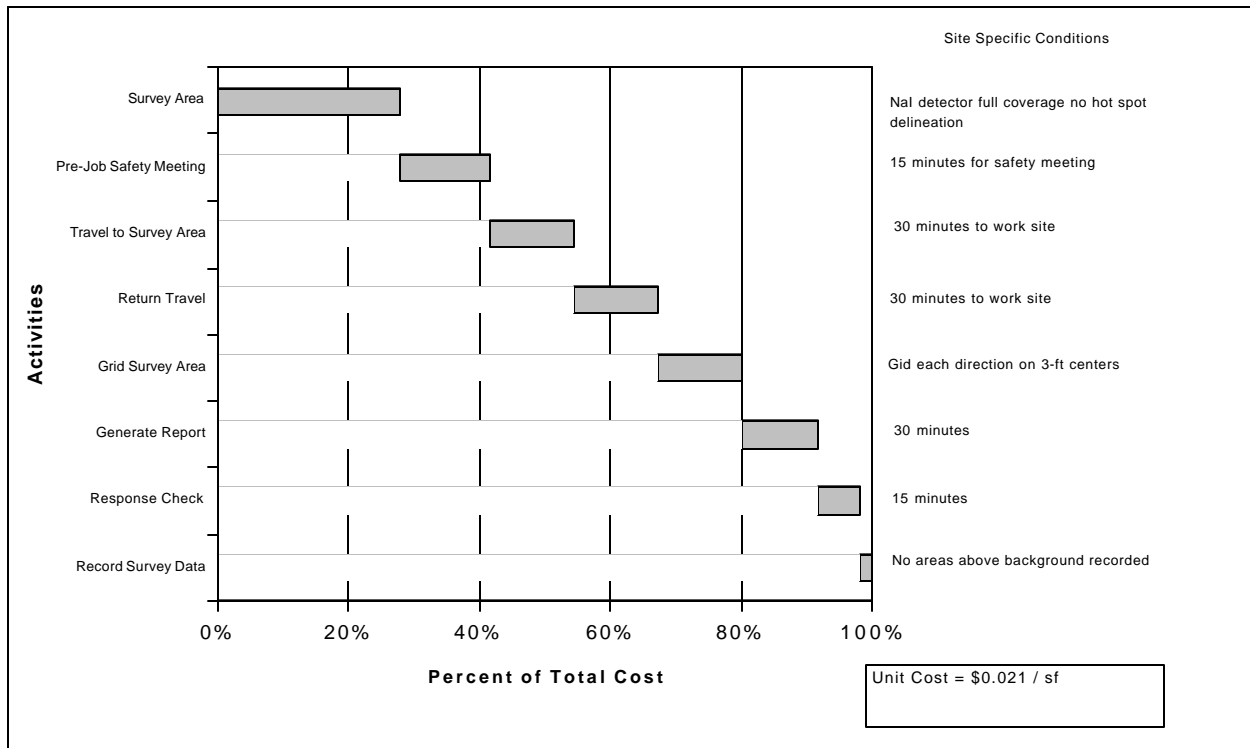

Figure 9. Breakdown of baseline technology unit cost.

Payback Period

For this demonstration, the innovative technology saves approximately \$0.005/sf over the baseline. At this rate of savings, the purchase price of \$121,404 (including HUMMER and instrumentation) would be recovered by using the innovative technology to survey approximately 24280800 sf (558 acres).

Observed Costs for Demonstration

Figure 10 summarizes the costs observed for the innovative and baseline technology for surveying 26 locations. The details of these costs are shown in Appendix B and includes Tables B-1 and B-2 which can be used to compute site specific costs by adjusting for different labor rates, crew makeup, etc.,

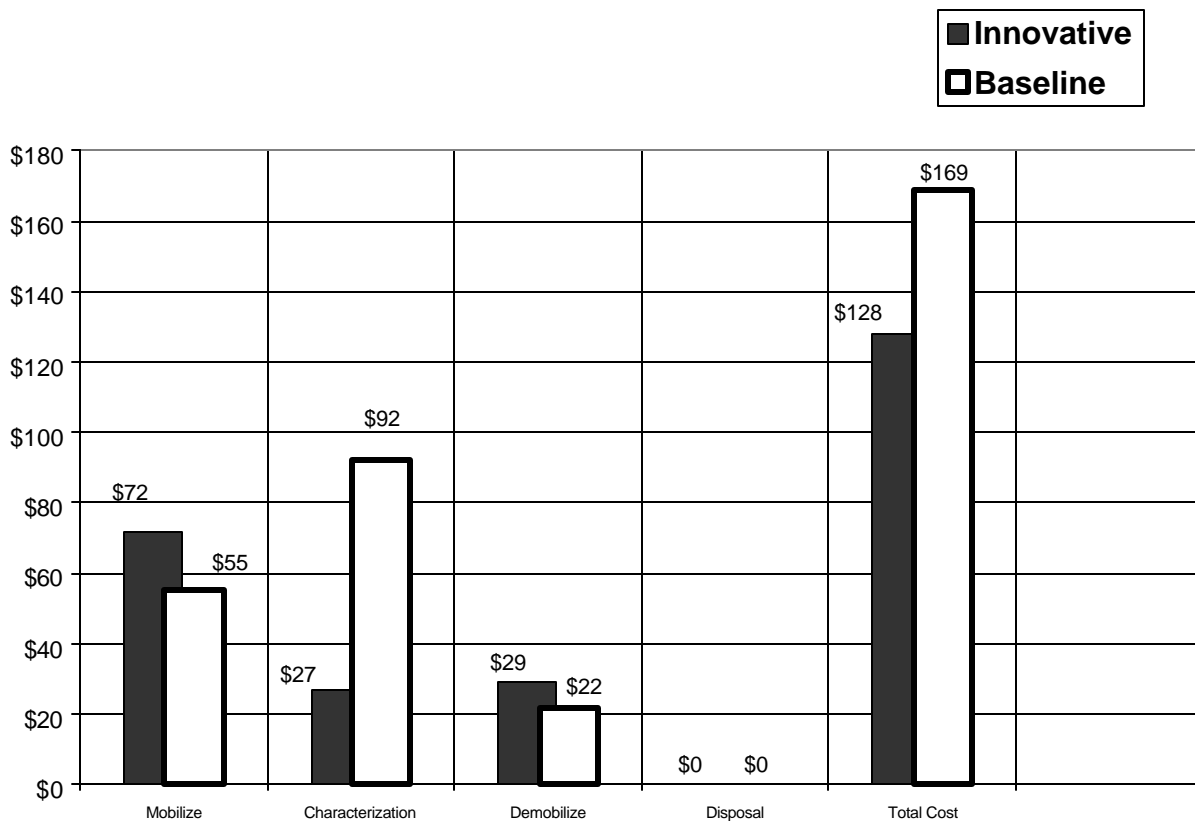

Figure 10. Summary of technology costs.

Cost Conclusions

The innovative technology is approximately 76% of the cost of the baseline technology for this demonstration. The innovative technology has a production rate that is four times greater than the baseline's production for radiological surveys. The production rates for the innovative and the baseline technologies are summarized below in Table 4:

Table 4. Summary of sampling production rates

Type of Work	Production Rate	
	Innovative Technology	Baseline Technology
Mark Grid	Not needed	16,000 sf/hr
Survey Area	32,000 sf/hr	7,407 sf/hr

The production rate for the baseline reflects using the NaI detector. If "hot spots" were identified then delineation of the "hot spot" would be normal practice. No "hot spots" were delineated during this demonstration. The number of "hot spots" and size of the "hot spots" can have a significant impact on the overall production rate and cost. For example, delineating 10-sf would have added approximately 20 minutes to the overall survey time. The additional 20 minutes reduces the baseline's production rate by 25% and increases the total cost by approximately 10%. In addition to the "hot spot" delineation, the baseline production rate is greatly affected by the coverage requirements. In this demonstration, 100% of the surface was surveyed. Other situations may allow less complete coverage and would directly affect the cost. Obstacles and uneven surfaces affect the production rate for the GPRS. The production rate observed in this demonstration is for near optimum driving conditions. Although adverse driving conditions will affect the production rate for GPRS, the overall affect on cost is anticipated to be small.

This cost analysis is based on a one-person crew for both innovative and baseline technology costs. In some situations, safety requirements may make a "buddy" necessary. The additional crewmember would increase costs by approximately 60%.

The GPRS costs are based on the most expensive configuration of the equipment (upper limit costs for detection equipment plus HUMMER cost). A less expensive configuration (bottom limit cost for detection equipment and less expensive four-wheel-drive vehicle) could reduce equipment rates by 25% and overall costs by 12%.

SECTION 6 REGULATORY AND POLICY ISSUES

Regulatory Considerations

The GPRS meets the requirements for 10 CFR, Chapter III, Department of Energy, Part 835, and "Occupational Radiation Protection." It also meets the requirements specified in DOE-STD-1098-99, "Radiological Control," dated July 1999. In order to properly perform the daily response check, the operators must be trained as a source user and check the gamma source (Source # H-007) out from the Central Facility Area RCTs. For this demonstration, a test plan and the technical procedure requirement (TPR-EM-ESP-5.4, "Surface Radiation Surveys Using the GPRS") covered the use of the GPRS under the INEEL LSDDP.

Safety, Risks, Benefits, and Community Reaction

The safety issue associated with the use of the GPRS is primarily driving hazards. These risks are easily mitigated through the use of two different people (i.e., one driver and one passenger) during surveys. The passenger is responsible for watching for potential hazards on the right side of the vehicle, as well as ensuring the information is being properly acquired. The risks associated with the use of the GPRS are routinely acceptable to the public.

SECTION 7

LESSONS LEARNED

Implementation Considerations

The GPRS is a mature technology that performed well during the INEEL demonstration. Operating the survey unit required no special skills to use; however, the Geosoft™ software required the user to be trained to understand how to operate. According to the operators, this technology was much easier and faster to complete a large surface survey. Once the personnel had been trained with this specific software, the system was user-friendly and able to generate a higher quality of detail for documenting the extent of radiological contamination. Items that should be considered before implementing the GPRS include the following:

- Daily response check on the detectors should be conducted prior to conducting the survey to ensure the plastic scintillators are properly responding.
- Annual preventative maintenance needs to be performed on the survey unit.
- Measurements are collected at a height of 3 ft and an optimal speed of 5 mph.
- During adverse weather conditions (i.e., winter months) the detector unit should be removed from the vehicle and stored inside doors to protect the integrity of the detectors.
- Historical information regarding the survey area needs to include possible radiological constituents. This technology is only applicable to gamma-emitting radionuclides.
- Weather and soil conditions could affect the measurements and the decontamination requirements.
- Background and trigger limits for the radiation measurements need to be determined prior to entering the survey area. Generally, background measurements are collected from the adjacent area that is considered clean or with similar soil chemistry.

Technology Limitations and Needs for Future Development

As mentioned above, this demonstration went rather well. It was able to identify a subsidence area that was overlooked by the baseline technology. However, the GPRS technology can only detect gamma-emitting radionuclides. If this technology is needed to survey in a contaminated area containing alpha or beta-emitting radionuclides, it could detect them. This system operates at a level of 3 ft above the surface. The user to calculate these other radiological constituents, if the relationships between the various radionuclides have been pre-determined could apply scaling factors. Normally, this relationship is from analytical results. Depending upon the amount of moisture in the soil of the survey area, this could affect the measurements. The detector assembly is fairly heavy (approximately 250 pounds); so, at least two people are required to remove it. Ideally, this unit can be removed by an engine hoist, which imposes additional training requirements.

A need for future development would be to retrofit this technology with a real-time capability for identifying the gamma-emitting radionuclides. Perhaps simply implementing a sodium iodide detector using the quadratic compression capability would allow this system to accomplish this task. This would enhance the capability of this technology and assist with the characterization process for unknown contaminated areas. However, it should be used with a suite of additional tools (i.e., In-Situ Gamma Spectroscopy) to quantify and identify the gamma constituents of this survey area.

Another enhancement might be to place a soil moisture probe on the system so that frequency measurements can be made to determine if the moisture content is affecting the measurements. In addition, if the system had the ability to automatically mark locations of interests (i.e., above trigger limits), this would expedite the clean-up process for D&D.

Technology Selection Considerations

Based on the INEEL demonstration and the information provided in Appendix C, GPRS technology is a better methodology for conducting large area survey measurements rather than using the baseline technology. GPRS can provide a better coverage of the survey area and provide known coordinates for further actions, once identified. A visual representation of the extent of contamination can be generated and assist with verifying or validating the decision making process.

The initial capital invested into this technology could be paid off in a relatively short time depending upon the amount of large area surveys needing to be characterized. As shown with this demonstration, a 77% labor savings was calculated. However, if the end user has limited use for this technology, it may be too costly.

APPENDIX A REFERENCES

Lockheed Martin Idaho Technologies Company, 1999, Idaho National Engineering and Environmental Laboratory Document TPR-EM-ESP-2.1, "*Surface Radiation Surveys Using the GPRS*", Rev.1.

APPENDIX B

COST COMPARISON DETAILS

Basis of Estimated Cost

The estimates for the innovative and baseline technologies are based on activities that were observed during the demonstration or are based on experience with similar types of work at INEEL. The estimate is structured so that the activities are grouped under higher-level work titles per the work breakdown structure shown in the *Hazardous, Toxic, Radioactive Waste Remedial Action Work Breakdown Structure and Data Dictionary* (HTRW RA WBS) (USACE 1996). The HTRW RA WBS, developed by an interagency group, is used in this analysis to provide consistency with the established national standards.

The following assumptions were used in computing the hourly rates for work crews and equipment:

- The innovative and the baseline equipment are assumed to be owned by the Government.
- The equipment rates for Government ownership are computed by amortizing the purchase price of the equipment, plus a procurement cost of 5.2% of the purchase price.
- The equipment hourly rates assume a service life of 10 years for the GPS and detection instruments and 15 years for the HUMMER. An annual usage of 960 hours per year is assumed for the innovative and baseline equipment based on past usage at INEEL.
- The equipment hourly rates for the Government's ownership are based on general guidance contained in Office of Management and Budget (OMB) Circular No. A-94, *Cost Effectiveness Analysis*
- The crews are based on similar work at INEEL.
- The standard labor rates established by the INEEL are used in this estimate and include salary, fringe, departmental overhead, material handling markups, and facility service center markups.
- The equipment rates and the labor rates do not include the Lockheed Martin general and administrative (G&A) markups. The G&A are omitted from this analysis to facilitate understanding and comparison with costs for the individual site. The G&A rates for each DOE site varies in magnitude and in the way they are applied. Decision-makers seeking site-specific costs can apply their site's rates to this analysis without having to first back out the rates used at the INEEL.

The analysis does not include costs for oversight engineering, quality assurance, administrative costs for the demonstration, or work plan preparation costs. This cost analysis omits some non-productive costs. The demonstration began at 7:30 am and was completed by 11:50 am (required 4-hours and 20-minutes). But, the activities and duration included in this cost analysis account for only 2-hours and 40-minutes. Some of the activities omitted from this cost analysis related only to the demonstration (such as waiting on the photographer). Miscellaneous delays were also omitted if they did not relate directly to the work activity (such as the delay between the completion of the response check and the start of the pre-job briefing).

Activity Descriptions

The scope, computation of production rates, and assumptions (if any) for each work activity is described in this section.

Mobilization (WBS 331.01)

Response Check: Perform daily response checks on the radiological instrumentation. It usually involves checking the battery to make sure it is properly working and instrumentation responds to a known radiological source. A radiation control technician performs response check.

Pre-Job Safety Meeting: The duration for the pre-job safety meeting is based upon the observed time for the demonstration. The labor costs for this activity are based upon an assumed crew (rather than the actual

demonstration participants, and all subsequent activities are based on the assumed crews). The baseline assumes one radiation control technician and the innovative assumes one field-sampling technician.

Travel to Survey Area: Crew's travel time to work area. The duration is based on the observed time for the demonstration.

Characterization (WBS 331.17)

Grid Survey Area: The size of the area was 80 ft by 100 ft. The grid lines were 3 ft on center in both directions to allow 100% coverage by the baseline technology. Observed production rate for establishing the grid was 16,000 sf/hr (this is adjusted from 32,000 sf/hr for two grid markers to a production rate of 16,000 sf/hr for a crew of one).

Survey Area: The surveyed area for the demonstration was 8,000 sf. The observed production rate was 7,407 sf/hr for the baseline based on using the Nal detector and 32,000 sf/hr for the innovative. The surveying with the Nal detector covered 100% of the area.

Delineate Hot Spots: This activity would have included a cost for the baseline technology for delineating any "hot spots" identified by the Nal detector. No "hot spots" were identified during this demonstration and no costs for this are included in this estimate.

Record Survey Data: The RCT documents the field survey information. This information includes any areas identified as radiologically elevated. The estimate is based on the observed time from the demonstration.

Generate Report: The estimate for GPRS is based on the observed time from the demonstration. The estimate of the baseline cost is based on similar work at INEEL.

Demobilization (WBS 331.21)

Return Travel: The estimate is based on the observed time from the demonstration.

Disposal (WBS 331.18)

No waste disposal was required for this demonstration.

Cost Estimate Details

The cost analysis details are summarized in Tables B-1 and B-2. The tables breaks out each member of the crew, each labor rate, each piece of equipment used, each equipment rate, each activity duration, and all production rates so that site specific differences in these items can be identified and a site specific cost estimate may be developed.

Table B-1. Innovative Technology Cost Summary

Work Breakdown Structure	Unit	Unit Cost \$/unit	Quantity	Total Cost	Computation of Unit Cost							Comments
					Production Rate	Duration (hr)	Labor Item	\$/hr	Equipment Items	\$/hr	Other \$	
Facility Deactivation, Decommissioning, & Dismantlement					TOTAL COST FOR DEMONSTRATION =							\$ 127.94
Mobilization (WBS 331.01)										Subtotal =		\$ 71.49
Response Check	ea	14.71	1	\$ 14.71		0.25	RCT	39.45	GPRS on standby	19.38		
Pre-Job Safety Meeting	ea	27.52	1	\$ 27.52		0.25	ES+JS	90.68	GPRS on standby	19.38		
Travel to Survey Area	ea	29.27	1	\$ 29.27		0.50	ES	39.15	GPRS on standby	19.38		
Characterization (WBS 331.17)										Subtotal =		\$ 27.19
Grid Survey Area	sf	0.00	0	\$ -								Not needed for GPRS
Survey Area	sf	0.00	8,000	\$ 14.63	32000		FS	39.15	GPRS	19.38		32000sf/hr production rate
Delineate Hot Spots	sf											
Record Survey Data	ea											Not needed for GPRS
Generate Report	ea	12.56	1	\$ 12.56		0.17	EN	55.95	GPRS on standby	19.38		10 minutes
Demobilization (WBS 331.21)										Subtotal =		\$ 29.27
Return Travel	ea	29.27	1	\$ 29.27		0.500	FS	39.15	GPRS on standby	19.38		
Disposal (WBS 331.18)										Subtotal =		\$ -
Labor and Equipment Rates used to Compute Unit Cost												
Crew Item	Rate \$/hr	Abbreviation	Crew Item	Rate \$/hr	Abbreviation	Equipment Item	Rate \$/hr	Abbreviation	Equipment Item	Rate \$/hr	Abbreviation	
Radiation Control Tech	39.45	RCT				GPRS	19.38	GPRS				
Field Sampler	39.15	ES										
Engineer	55.95	EN										
Job Supervisor	51.53	JS										

Notes:

1. Unit cost = (labor + equipment rate) X duration + other costs, or = (labor + equipment rate)/production rate + other costs
2. Abbreviations for units: ls = lump sum; ea = each; and, loc = location; ft³ = cubic feet.
3. Other abbreviations: PPE = personal protective equipment.

Table B-2. Baseline Technology Cost Summary

Work Breakdown Structure	Unit	Unit Cost \$/unit	Quantity	Total Cost	Computation of Unit Cost							Comments
					Production Rate	Duration (hr)	Labor Item	\$/hr	Equipment Items	\$/hr	Other \$	
Facility Deactivation, Decommissioning, & Dismantlement					TOTAL COST FOR DEMONSTRATION =							\$ 169.34
Mobilization (WBS 331.01)										Subtotal =	\$ 55.55	
Response Check	ea	10.47	1	\$ 10.47		0.25	RCT	39.45	Nal on standby	2.41		
Pre-Job Safety Meeting	ea	23.35	1	\$ 23.35		0.25	JS+RCT	90.98	Nal on standby	2.41		
Travel to Survey Area	ea	21.74	1	\$ 21.74		0.50	RCT	39.45	Nal & VH	4.03		
Characterization (WBS 331.17)										Subtotal =	\$ 92.05	
Grid Survey Area	sf	0.00	8,000	\$ 21.74	16000		RCT	39.45	Nal & VH standby	4.03	16000sf/hr production rate	
Survey Area	sf	0.01	8,000	\$ 46.96	7407		RCT	39.45	Nal & VH	4.03	7407sf/hr production rate	
Delineate Hot Spots	sf										No hot spots detected	
Record Survey Data	ea	3.62	1	\$ 3.62		0.08	RCT	39.45	Nal & VH standby	4.03	5 minutes	
Generate Report	ea	19.73	1	\$ 19.73		0.50	RCT	39.45			30 minutes	
Demobilization (WBS 331.21)										Subtotal =	\$ 21.74	
Return Travel	ea	21.74	1	\$ 21.74		0.50	RCT	39.45	Nal & VH	4.03		
Disposal (WBS 331.18)										Subtotal =	\$ -	
Labor and Equipment Rates used to Compute Unit Cost												
Crew Item	Rate \$/hr	Abbreviation	Crew Item	Rate \$/hr	Abbreviation	Equipment Item	Rate \$/hr	Abbreviation	Equipment Item	Rate \$/hr	Abbreviation	
Radiation Control Tech	39.45	RCT				Nal and Bicon	2.41	Nal				
Field Sampler	39.15	FS				2x4 vehicle	1.62	VH				
Engineer	55.95	EN										
Job Supervisor	51.53	JS										

Notes:

- Unit cost = (labor + equipment rate) X duration + other costs, or = (labor + equipment rate)/production rate + other costs
- Abbreviations for units: ls = lump sum; ea = each; and, loc = location; ft³ = cubic feet.
- Other abbreviations: PPE = personal protective equipment.

APPENDIX C ADDITIONAL GPRS RESULTS

INEEL GPRS SURVEY RESULTS

Historically, the GPRS technology at the INEEL has been as part of the routine Environmental Surveillance Program (ESP). Recent modifications have made this technology more valuable in large area surveys conducted at the Radioactive Waste Management Complex (RWMC) Subsurface Disposal Area (SDA). This information has been used to evaluate the waste confinement and trend the radiological values at the SDA. The SDA is approximately 100 acres in size and usually requires one week to survey all the accessible areas within the SDA. In addition, the graphical representation can be compared to each other to assist operations in locating any areas of concern.



Figure C-1. Example of the Spring RWMC Survey Results

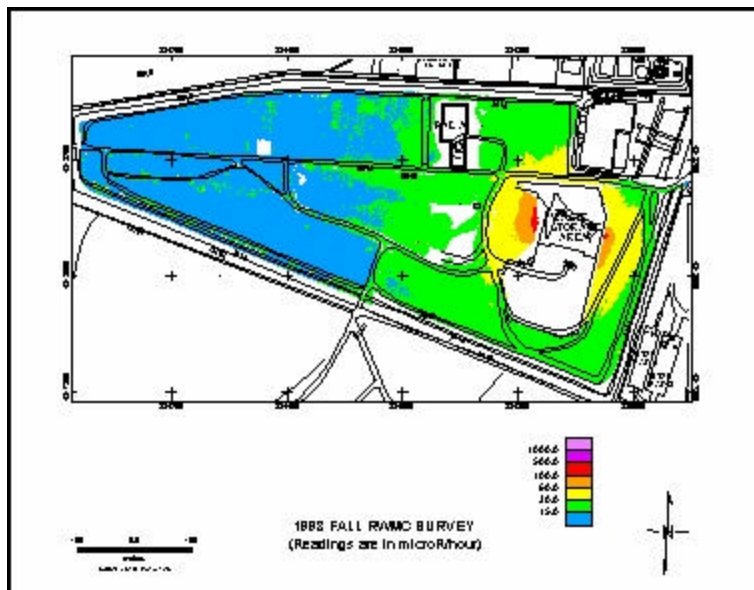

Figure C-2. Example of the Fall RWMC Survey Results

Figure C-3 shows the survey results from the Organic Moderated Reactor Facility (OMRE). This area at OMRE is less than two acres in size and usually required about 4 hours to complete. This area is surveyed annually by ESP and used for trending purposes.

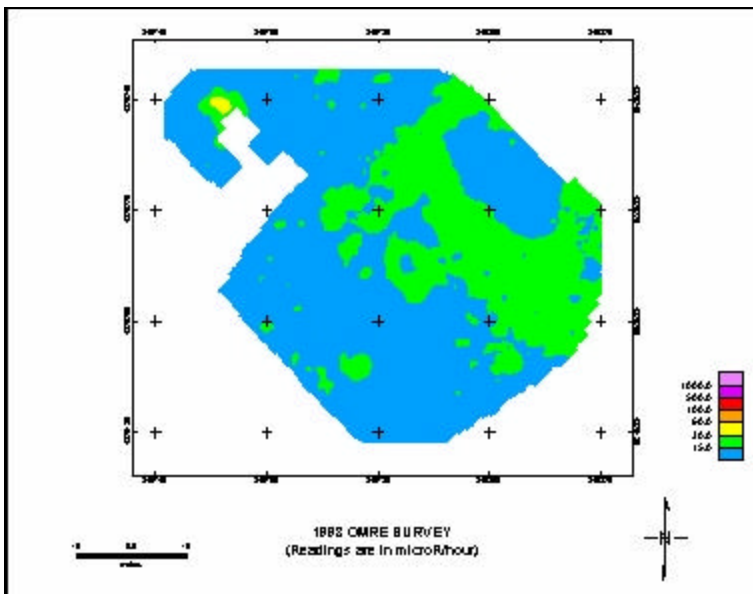

Figure C-3. Example of the OMRE Survey Results

In Figures C-4 and C-5 show the results over a two year period from a soil contamination area located outside the fence line of the Idaho Nuclear Technology and Environmental Complex (INTEC) in the northeast corner. These surveys are conducted annually to assist various programs at the INEEL in making decisions about the contamination.

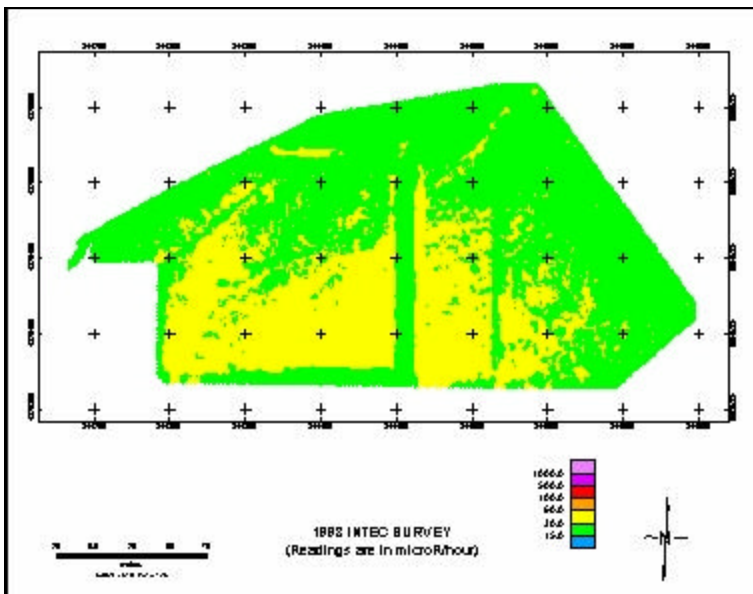

Figure C-4. Example of the 1988 INTEC Survey Results

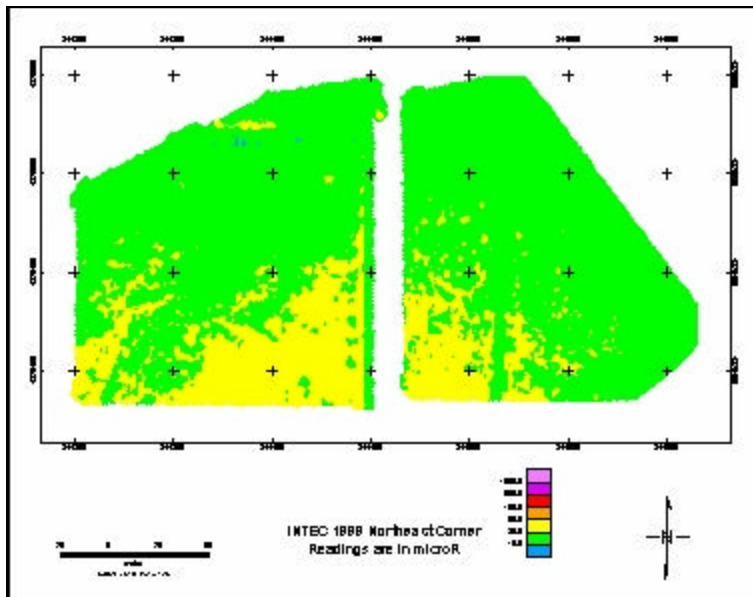

Figure C-5. Example of the 1999 INTEC Survey Results.

APPENDIX D

ACRONYMS AND ABBREVIATIONS

\$/sf	Dollar per square foot
CFA	Central Facility Area
CFR	Code of Federal Regulation
D&D	Decontamination and Decommissioning
DDFA	Deactivation and Decommissioning Focus Area
d-gps	Differential global positioning system
DOE	Department of Energy
ESP	Environmental Surveillance Program
G&A	General and Administrative
GPRS	Global Positioning Radiometric Scanner
HTRW RA WBS	Hazardous, Toxic Radioactive Waste Remedial Action Work Breakdown Structure and Data Dictionary
IET	Initial Engine Test
INEEL	Idaho National Engineering and Environmental Laboratory
LSDDP	Large Scale Demonstration and Deployment Project
mph	Miles per hour
Nal	Sodium iodide
NETC	National Energy and Technology Center
OMB	Office of Management and Budget (OMB)
OMRE	Organic Moderated Reactor Experiment
OST	Office of Science and Technology
PPE	Personal Protective Equipment
RCT	Radiological Control Technician
RWMC	Radioactive Waste Management Complex
SDA	Subsurface Disposal Area